

◆ PRECISION INSTRUMENTS FOR TEST AND MEASUREMENT ◆

Operation Manual

**MODEL 1491
PRECISION
DECADE INDUCTOR**



© Copyright- 2000 IET Labs, Inc.



IET LABS, INC.

534 Main Street, Westbury, NY 11590

TEL: (516) 334-5959 • (800) 899-8438 • FAX: (516) 334-5988

www.ietlabs.com

1491 im outer cover



IET LABS, INC.

534 Main Street, Westbury, NY 11590

Tel (516) 334-5959 (800) 899-8438 Fax (516) 334-5988 <http://www.ietlabs.com>

Manual & Programmable Standards, Substituters, & Test Instruments

- [New Products](#)
 - [Find a Product](#)
 - [Technical Applications](#)
 - [Request a Quote](#)
 - [Price List](#)
 - [Place an Order](#)
 - [Request a Catalog](#)
 - [Contact Us](#)
 - [About IET](#)
- If you need products or service by Genrad, esi, Biddle, or others.

STANDARDS, DECADES STROBES

Formerly Manufactured By:
QuadTech/GenRad(General Radio)

*Now being manufactured,
serviced, calibrated,
and fully supported
by IET LABS*

**COST-EFFECTIVE QUALITY
STANDARD OR CUSTOM SOLUTION
R-L-C•RTD•VOLTAGE
CURRENT•PROCESS CONTROL**

Product Area of Interest

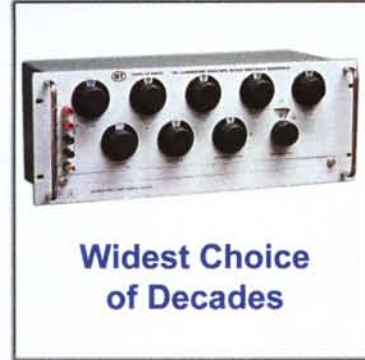

**Widest Choice
of Decades**

**IET is compliant with ISO 9001,
ISO/IEC 17025, ANSI Z540-1-1994,
and MIL-STD-45662A**

Calibration Test Measurement Metrology

[Find a Products](#) | [Technical Applications](#) | [Request a Quote](#) | [Place an Order](#) | [Free Offer](#) | [Request a Catalog](#) | [Contact Us](#)

© Copyright 1999 - 2001 IET Labs, Inc. All rights reserved.
Problems or Comments? Contact webmaster@ietlabs.com

To navigate our easy to use website for quick access to specifications and prices:

1. Select **Find a Product** to go to a convenient scrolling thumbnail catalog and then to detailed data sheets as desired; or:
2. Select **STANDARDS DECADES STROBES** for products formerly manufactured by **GenRad (General Radio)** or **QuadTech**.

Since 1976, IET labs has had a long-standing commitment to **conform the instruments and standards we offer to the customer's needs** rather than to have the customer settle for what is available. We devote our customer service and applications entirely to the customer's satisfaction in the quality standards, test instruments and calibration service we provide.

- Combinations of functions, special ranges, ratings, or accuracies.
- Replacement for discontinued models from other manufacturers.
- Calibration and repair services - NIST traceable.
- Compliant with ISO 9001, ISO 17025, ANSI Z540-1-1994, and MIL-STD-45662A.

Capabilities

- R: 20 $\mu\Omega$ -1 T Ω
- C: <1 pF - 1 F
- L: 100 μ H-100 H

- Accuracy to 1 ppm
- Resolution to 0.1 ppm
- Voltage to 20 kV
- Power to over 1000 W
- Programmable IEEE-488 or BCD



*The World Standard in Metrology
Since 1915*
Now continuing the *GenRad* tradition

*Featuring instruments formerly
manufactured by
GenRad/General Radio/QuadTech*

WARRANTY

We warrant that this product is free from defects in material and workmanship and, when properly used, will perform in accordance with applicable IET specifications. If within one year after original shipment, it is found not to meet this standard, it will be repaired or, at the option of IET, replaced at no charge when returned to IET. Changes in this product not approved by IET or application of voltages or currents greater than those allowed by the specifications shall void this warranty. IET shall not be liable for any indirect, special, or consequential damages, even if notice has been given to the possibility of such damages.

THIS WARRANTY IS IN LIEU OF ALL OTHER WARRANTIES, EXPRESSED OR IMPLIED, INCLUDING BUT NOT LIMITED TO, ANY IMPLIED WARRANTY OF MERCHANTABILITY OR FITNESS FOR ANY PARTICULAR PURPOSE.



WARNING



OBSERVE ALL SAFETY RULES
WHEN WORKING WITH HIGH VOLTAGES OR LINE VOLTAGES.

**Dangerous voltages may be present inside this instrument. Do not open the case
Refer servicing to qualified personnel**

HIGH VOLTAGES MAY BE PRESENT AT THE TERMINALS OF THIS INSTRUMENT

WHENEVER HAZARDOUS VOLTAGES (> 45 V) ARE USED, TAKE ALL MEASURES TO
AVOID ACCIDENTAL CONTACT WITH ANY LIVE COMPONENTS.

USE MAXIMUM INSULATION AND MINIMIZE THE USE OF BARE
CONDUCTORS WHEN USING THIS INSTRUMENT.

Use extreme caution when working with bare conductors or bus bars.

WHEN WORKING WITH HIGH VOLTAGES, POST WARNING SIGNS AND
KEEP UNREQUIRED PERSONNEL SAFELY AWAY.



CAUTION



DO NOT APPLY ANY VOLTAGES OR CURRENTS TO THE TERMINALS OF THIS
INSTRUMENT IN EXCESS OF THE MAXIMUM LIMITS INDICATED ON
THE FRONT PANEL OR THE OPERATING GUIDE LABEL.

INSTRUCTIONS



Figure 1-1. Type 1491-G Decade Inductor.

1491 Decade Inductor

SPECIFICATIONS

1491 DECADE INDUCTOR

(see also specifications for 940 decade units)

Frequency Characteristics: Refer to section 2.

Zero Inductance: Approx 1 μ H.

Max Voltage: 500 V rms. Switch will break circuit at 500 V if turned rapidly, but voltages above 150 V may cause destructive arcing with switch between detent positions.

Terminals: Binding posts on $\frac{3}{4}$ -in. centers; separate ground terminal provided. Terminal board for rear connection.

Mounting: Lab-Bench Cabinet.

Dimensions (width x height x depth):

Model	Mounting	Dimensions (in.)	Dimensions (mm)
1491-A, -B, -C	Bench	12 $\frac{3}{4}$ x 8 $\frac{3}{4}$ x 6 $\frac{1}{2}$	325 x 225 x 170
	Rack	19 x 8 $\frac{3}{4}$ x 4 $\frac{7}{8}$	485 x 225 x 125
1491-D, -F, -G	Bench	17 x 8 $\frac{3}{4}$ x 6 $\frac{1}{2}$	435 x 225 x 170
	Rack	19 x 8 $\frac{3}{4}$ x 4 $\frac{7}{8}$	485 x 225 x 125

Weight (bench models, add 1 $\frac{3}{4}$ lb (0.8 kg); for rack models):

Model	Net	Shipping (est)
1491-A, -B, -C	18 lb (8.5 kg)	25 lb (11.7 kg)
1491-D, -F	23 lb (10.5 kg)	30 lb (13.7 kg)
1491-G	26 $\frac{1}{2}$ lb (12.5 kg)	34 lb (15.5 kg)

Catalog Number		Description	Inductance		940's Included
Bench	Rack		Total	Steps	
Decade Inductor					
1491-9701*	1491-9711*	1491-A	0.111 H	0.0001 H	DD, E, F
1491-9706*	1491-9716*	1491-F	1.111 H	0.0001 H	DD, E, F, G
1491-9703*	1491-9713*	1491-C	1.11 H	0.001 H	E, F, G
1491-9707	1491-9717	1491-G	11.111 H	0.0001 H	DD, E, F, G, H
1491-9704	1491-9714	1491-D	11.11 H	0.001 H	E, F, G, H
1491-9702*	1491-9712*	1491-B	11.1 H	0.01 H	F, G, H

*Discontinued

940 DECADE-INDUCTOR UNIT

Accuracy: Each unit is adjusted so that its inductance at zero frequency and initial permeability will be the nominal value within the accuracy tolerance given in the following table:

Unit	940-DD	940-E	940-F	940-G	940-H
Inductance per step	100 μ H	1 mH	10 mH	100 mH	1 H
Accuracy	$\pm 2\%$	$\pm 2\%$	1.6%	$\pm 0.8\%$	$\pm 0.8\%$

Frequency Characteristics (and other operating characteristics): Refer to section 2.

Dc Resistance: Approx 45 Ω per henry.

Temperature Coefficient: Approx -80 ppm per degree C between 16 $^{\circ}$ and 32 $^{\circ}$ C.

1491-0100-00

Max Safe Current: Approx 200 times the pertinent I_n value (30 times for the 940-DD). Max current engraved on dial.

Description	Inductance	
	Total	Steps
Decade Inductor*		
940-DD	1 mH	100 μ H
940-E	0.01 H	0.001 H
940-F	0.1 H	0.01 H
940-G	1 H	0.1 H
940-H	10 H	1 H

* Refer to parts list for 940 replacement units for 1491 Decade Inductors.

INTRODUCTION

1.1 PURPOSE.

The 1491 Decade Inductor is an assembly of several 940 Decade-Inductor units in a single metal cabinet. These inductance decades are convenient elements for use in wave filters, equalizers, and tuned circuits throughout the range of audio and low radio frequencies. As components in oscillators, analyzers, and similar equipment, they are especially useful during the preliminary design period, when the ability to vary circuit elements over relatively wide ranges is necessary to determine optimum operating values.

1.2 DESCRIPTION.

All 1491 models are available for either bench use or installation in a relay rack. The panel binding posts are for general use and connection may also be made at the rear, as is often preferred for rack-mounted decade boxes.

The individual decade units have no electrical connection to the panel, but a separate ground terminal is provided, which can be connected to the adjacent low terminal, leading to the smallest decade. Each decade unit is an assembly of four inductors (relative values, 1, 2, 2, 5) wound on molybdenum-permalloy dust cores that are combined by switching to give the

eleven successive values from 0 to X ($X = 10$). The decade switch has high-quality ceramic stator-and-rotor members and well-defined ball-and-socket detents. All contacts are made of a silver alloy and have positive wiping action.

Shielded toroidal cores are used for small mutual inductance and minimum effect from external fields.

1.3 ACCESSORIES AVAILABLE.

Rack-Adaptor Sets are normally supplied with the relay-rack models. These adaptor sets (listed in Table 1-2) are also available for mounting 1491 bench models in a standard 19-inch relay rack.

Table 1-1
RACK-ADAPTOR SETS FOR
1491 DECADA INDUCTORS

Type	Catalog Number
1491-A, -B, -C	0480-9715
1491-D, -F, -G	0480-9705

INSTALLATION AND OPERATION

2.1 DIMENSIONS.

See Figure 2-1 for approximate dimensions of all 1491 Decade Inductors.

2.2 RELAY-RACK INSTALLATION.

• 1491-A, -B, -C. To install one of these decade inductors in a standard 19-inch relay rack, use the Rack-Adaptor Set (parts listed in Table 2-1), refer to Figure 2-2, and proceed as follows:

- Remove the cabinet (refer to paragraph 3.4.2).
- Pierce and push out the plugs from the four bosses (c) on the inner sides of the cabinet, near the front. (Be careful not to damage the threads.)
- Press the sub panel (D) into the blank panel (E).
- Attach the short flange of the blank panel (E) to the side of the cabinet, using two screws (F, Table 2-1) as indicated in Figure 2-2. The blank panel may be attached to either side of the cabinet. Note that the screws (F) enter in opposite directions — one from the inside of the cabinet and one from the outside.

e. Pierce and push out the plug in the lower rear boss (G) on the side of the cabinet where the support bracket (H) is to be attached.

f. Attach one end of the support bracket (H) to the lower rear boss (G), using a 5/16-inch screw (J). Use the end of the support bracket with the elongated hole.

g. Attach the other end of the support bracket (H) to the lower rear hole in the sub panel (D), using a 5/16-inch screw (K).

h. Attach one Rack-Adaptor Assembly (Q) to the other side (left side in Figure 2-2) of the cabinet, using two 5/16-inch screws (L). Note that the screws enter the holes in opposite directions.

i. Attach the remaining Rack-Adaptor Assembly (Q) to end of the blank panel (E), using two 5/16-inch screws (M). Note, that these screws enter in opposite directions and pass through the holes in sub panel (D), as shown.

j. Install the instrument in the cabinet (refer to paragraph 3.4.2).

k. Place a straight edge across the instrument panel and the blank panel (E). Loosen the screw (J) in the support bracket (H), adjust the alignment of the blank panel (E) so that it forms a straight line with

Table 2-1
RACK-ADAPTOR SET, P/N 0480-9715

Quantity	Description	Fig. Ref.	Part Number
1	Blank Panel	E	0480-8925
1	Sub Panel	D	0480-8945
2	Rack-Adaptor Assembly	Q	0480-4905
1	Support Bracket	H	0480-8522
1	Hardware Set, (includes the following parts):	—	0480-3080
8	Screw, BH, No. 10-32, 5/16	F, J, K, L, M	—
4	Screw, BH, No. 10-32, 9/16, with nylon-cup washers	N	—

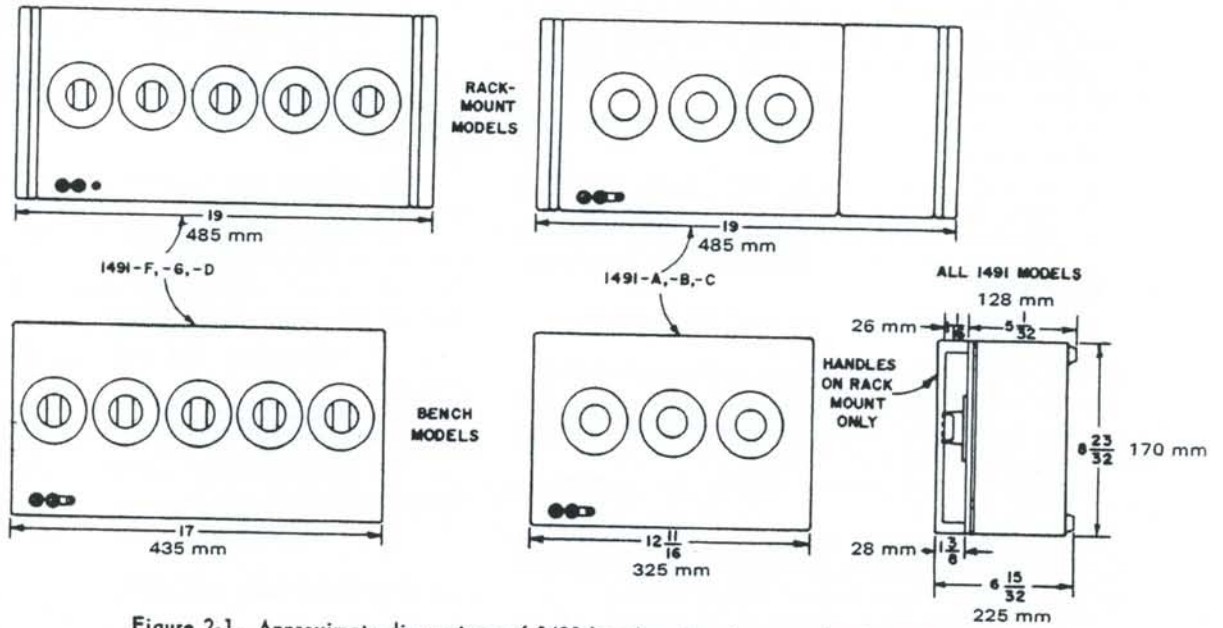

Figure 2-1. Approximate dimensions of 1491 bench and rack-mount decade inductors.

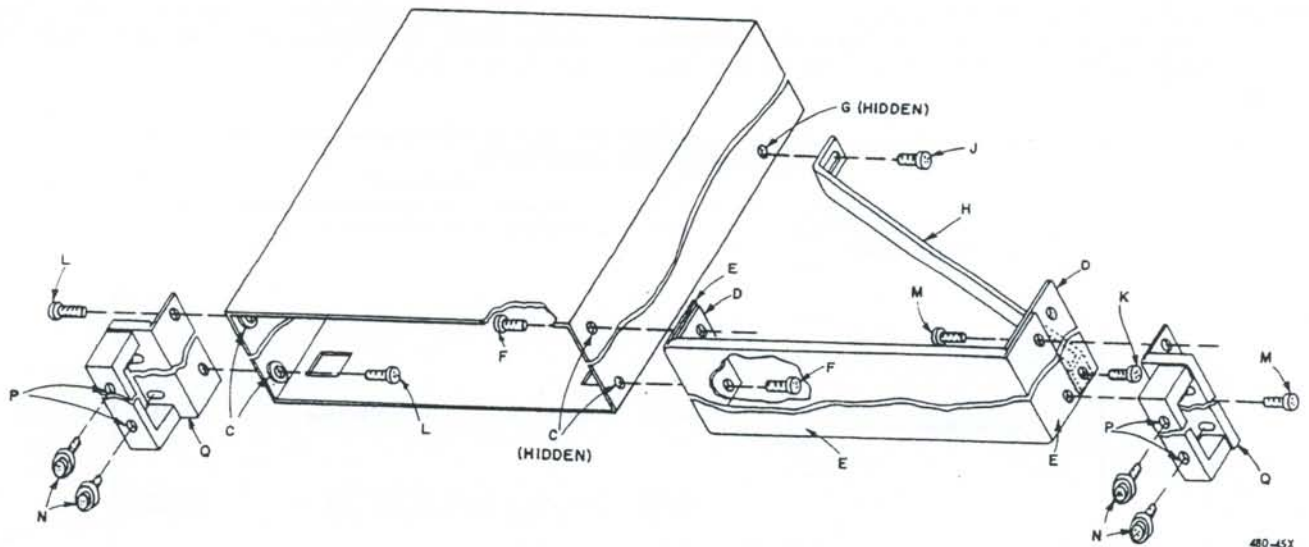

Figure 2-2. Assembly of the 1491 for installation in a relay rack.

Quantity	Description	Fig. Ref.	Part Number
2	Rack-Adaptor Assembly	Q	0480-4905
1	Hardware Set (includes the following parts):	—	0480-3080
8	Screw, BH, No. 10-32, 5/16	F, L	—
4	Screw, BH, No. 10-32, 9/16, with nylon-cup washers	N	—

the instrument panel, and tighten the support bracket screw (J) securely.

1. Slide the entire assembly into the relay rack and lock it in place with the four 9/16-inch screws (N). Tighten these screws by inserting a screwdriver through the holes in the handles.

To reconvert the instrument for bench use, proceed as follows:

- a. Remove the entire assembly from the relay rack. Remove the instrument from the cabinet.
- b. Remove the blank panel (E), the support bracket (H), and both Rack-Adaptor Assemblies (Q) from the cabinet.
- c. Reinstall the instrument in the cabinet.

• 1491-D, -F, -G. To install one of these decade inductors in a standard 19-inch relay rack, use the Rack-Adaptor Set (parts listed in Table 2-2), refer to Figure 2-2, and proceed as follows:

- a. Remove the cabinet (refer to paragraph 3.4.2).
- b. Pierce and push out the plugs from the four bosses (C) on the inner sides of the cabinet, near the front. (Be careful not to damage the threads.)
- c. Attach one Rack-Adaptor Assembly (Q) to the left side of the cabinet, using two 5/16-inch screws (L), as shown in Figure 2-2. Note that the screws enter the holes in opposite directions.
- d. Attach the other Rack-Adaptor Assembly (Q) to the right side of the cabinet, as described in step c.

NOTE

Parts E, H, and D, as shown in Figure 2-2, are not used with 1491-D, -F, and G. Rack-Adaptor Assembly (Q) is attached directly to the side of the cabinet.

e. Install the instrument in the cabinet (refer to paragraph 3.4.2).





f. Slide the assembly into the relay rack and lock it in place with the four 9/16-inch screws (N). Tighten these screws by inserting a screwdriver through the holes in the handles.

To reconvert the instrument for bench use, proceed as follows:

- a. Remove the entire assembly from the relay rack. Remove the instrument from the cabinet.
- b. Remove both Rack-Adaptor Assemblies (Q) from the cabinet.
- c. Reinstall the instrument in the cabinet.

2.3 CONNECTIONS - GENERAL.

The terminals on the 1491 are standard 3/4-inch-spaced binding posts that accept banana plugs, standard telephone tips, alligator clips, crocodile clips, spade terminals, and wire sizes up to No. 11. See Figure 2-3.

Type	Description	Catalog Number
 ← 274-NQ	Double-plug patch cord, in-line cord, 36" long	0274-9860
 ← 274-NP	Double-plug patch cord, right-angle cord, 36" long	0274-9880
 ← 274-NL	Shielded double-plug patch cord, 36" long	0274-9883
274-LLB 274-LLR	Single-plug patch cord, black, 36" long Single-plug patch cord, red, 36" long	0274-9468 0274-9492
 ←		

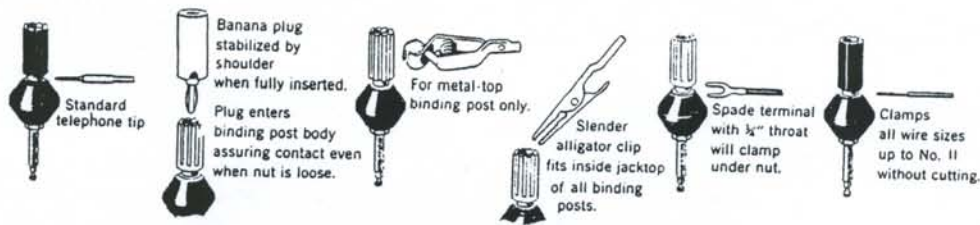

Figure 2-3. Methods of connection to binding-post terminals.

The banana-plug patch cords listed in Table 2-3 are GR catalog items that are readily available for use with the 1491 and associated instruments equipped with 3/4-inch-spaced binding posts.

2.3.1 FRONT-PANEL CONNECTIONS.

Standard 3/4-inch-spaced binding posts are available on the front panel for general use. The high (H) and low (L) binding posts are insulated from the panel and used for regular two-terminal applications. For grounded operation, connect the ground link between the ground (G) terminal and the low (L) terminal.

2.3.2 REAR CONNECTIONS.

A terminal board with high (H) and low (L) terminals is provided on the rear panel of the instrument. If grounded operation is desired, connect the ground link between the ground (G) terminal and the low (L) terminal on the front panel.

2.4 READOUT.

All 1491 decades have clear, easy-to-read dials with numbered steps from 0 to X (X = 10). When setting the decade switches, observe the decimal (reference) point on the panel and remember that X equals ten units. For example, using a 1491-G to obtain a value of 1.492 H, set the decade switches as follows:

1 . 4 9 2 0 = 1.492 H
 or
 1 . 4 9 1 X = 1.492 H (see Figure 1-1)

Note in the above example, that X is equal to a value of ten 0.0001 H units in that decade, or one 0.001 H unit in the next decade to the left.

The following example illustrates the result of setting all decades in the 1491-G to X:

Dial Settings X . X X X X
 Inductance Values 1 1 . 1 1 1 0 H

2.5 OPERATING CHARACTERISTICS.

The following paragraphs give a brief resume of the operating characteristics of the 1491 decade box and the 940 decade units.

2.5.1 FREQUENCY CHARACTERISTICS.

• 1491. The percentage increase in effective series inductance (above the zero-frequency value, L_0) can be obtained by interpolation in the accompanying

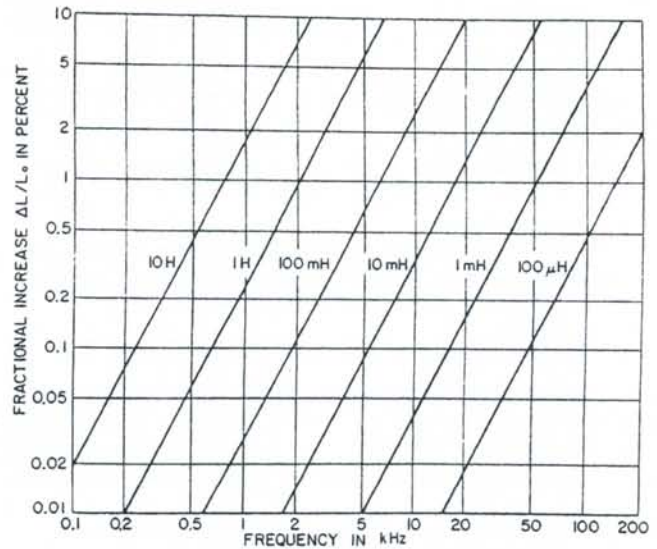

Figure 2-4. Variation of inductance with frequency, for the 1491 Decade Inductors (chassis grounded).

graph (see Figure 2-4) for any setting of the highest-value decade used, when the low (L) terminal is grounded to the cabinet.

• 940. Figure 2-5 shows the percentage increase in effective series inductance (above the zero-frequency value, L_0) with extreme settings (X = 10) of the individual decade-inductor units when the chassis is floating. Interpolate for intermediate settings.

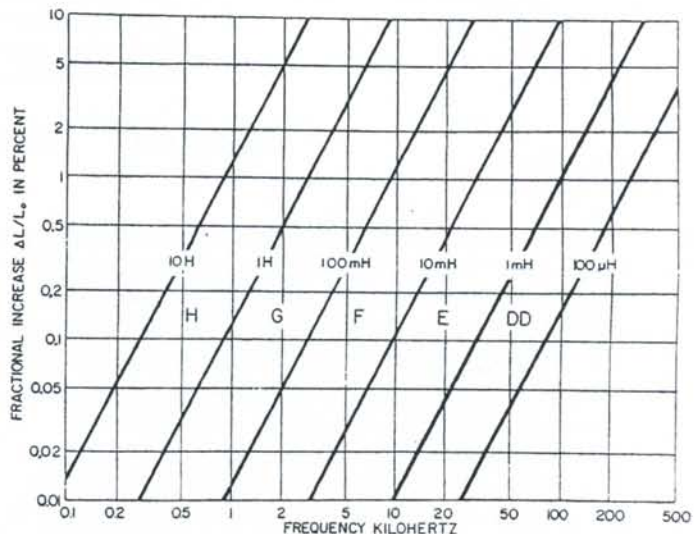

Figure 2-5. Change in effective inductance with frequency for the 940 Decade-Inductor Units (chassis floating).

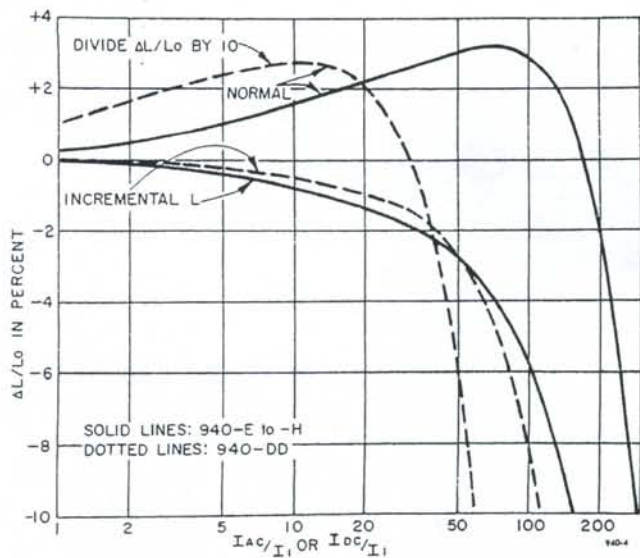

Figure 2-6. Percentage change in normal and incremental inductance with ac and bias current. Incremental curve is limited to an ac excitation less than I_1 .

2.5.2 INDUCTANCE CHANGES WITH CURRENT.

Percentage changes in inductance with ac current are shown in the NORMAL curves (see Figure 2-6) in terms of the ratio of the operating current (I_{ac}) to the current I_1 , given in Table 2-4. Note that,

Table 2-4

Switch Setting	RMS I_1 (mA)				
	0.1% Increase	0.25% Increase			
		940-DD	940-E	940-F	940-G
1	141	17	5.4	1.7	0.54
2, 3, 4	100	12	3.8	1.2	0.38
5, 6, 7, 8, 9, 10	63	8	2.4	0.8	0.24

for the dashed lines that represent the changes in the 940-DD decade, I_1 is the current that gives a 0.1% change and for the other 940 decades, I_1 gives a 0.25% change.

Values of I_1 , Table 2-4, are approximate and based on the largest inductor in the circuit for each setting.

Percentage changes in inductance due to dc bias current are shown in the INCREMENTAL curves (see Figure 2-6) in terms of the ratio of the dc current (I_{dc}) to the current I_1 , given in Table 2-4. The ac current must be less than I_1 for these curves to be valid.

2.5.3 STORAGE FACTOR, Q.

The 1491 inductors have maximum values of low-frequency storage factor (Q) of 200 and above. See Figure 2-7 for variations of Q with frequency for the individual 940 units.

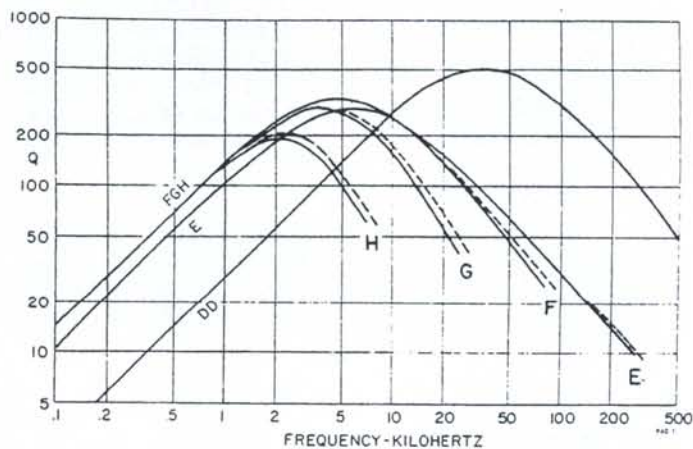

Figure 2-7. Variation of Q for the maximum inductance of each 940 Decade-Inductor Unit at low excitation levels. Dashed curves correspond to use with chassis floating.

CAUTION

The maximum voltage is 500 volts, rms. The switches will break the circuit at this voltage if turned rapidly, but voltages above 500 volts can cause destructive arcing when the switch is between detent positions.

SERVICE AND MAINTENANCE

3.1 WARRANTY

QuadTech warrants that Products are free from defects in material and workmanship and, when properly used, will perform in accordance with QuadTech's applicable published specifications. If within one (1) year after original shipment it is found not to meet this standard, it will be repaired, or at the option of QuadTech, replaced at no charge when returned to a QuadTech service facility. Changes in the Product not approved by QuadTech shall void this warranty. QuadTech shall not be liable for any indirect, special or consequential damages, even if notice has been given of the possibility of such damages. This warranty is in lieu of all other warranties,

expressed or implied, including, but not limited to any implied warranty or merchantability or fitness for a particular purpose.

THIS WARRANTY IS IN LIEU OF ALL OTHER WARRANTIES, EXPRESSED OR IMPLIED, INCLUDING, BUT NOT LIMITED TO, ANY IMPLIED WARRANTY OF MERCHANTABILITY OR FITNESS FOR A PARTICULAR PURPOSE.

3.2 SERVICE

Our warranty attests the quality of materials and workmanship in our products. If malfunction should be suspected, or other information be desired applications engineers are available for technical assistance. Application assistance is available in the U.S. by calling 508-485-3500 and asking for Applications Support. For support outside of the United States please contact your local QuadTech distributor.

Before returning an instrument to QuadTech for service please call our Service Department at 800-528-8885 for return material authorization. It will be necessary to include a Purchase Order Number to insure expedient processing, although units found to be in warranty will be repaired at no charge. For any questions on repair costs or shipment instructions please contact our Service Department at the above number. Return material should be sent freight prepaid, to:

QuadTech, Inc. Attn: Service Dept.
100 Nickerson Road
Marlborough, MA 01752

3.3 MINIMUM PERFORMANCE STANDARDS.

Total inductance values throughout the range of the 1491 can be checked for accuracy using any precision inductance or impedance bridge. The GR 1608 Impedance Bridge or the GR 1632 Inductance Bridge, or equivalent, are recommended for this purpose.

3.4 SERVICE AND MAINTENANCE NOTES.

3.4.1 GENERAL.

The 1491 Decade Inductor will need little service over the years. Should one of the decades become faulty, it is recommended that the complete decade assembly be replaced. This can be done by competent user personnel or the instrument can be returned to General Radio for service. Use the parts lists as a guide in determining which parts may be replaced.

3.4.2 1491 DISASSEMBLY.

Access to the interior of the 1491 is obtained by the following procedure:

a. Carefully place the instrument on a flat surface with the back of the cabinet facing upward. If the instrument is equipped for rack mounting, the handles must first be removed.

b. Remove the four No. 10-32 screws on the back of the cabinet.
c. Slide the cabinet up and off the instrument. To reassemble the instrument, reverse the above procedure and tighten the four No. 10-32 screws securely.

3.4.3 KNOB REPLACEMENT.

● Knob Removal. To remove a knob and dial assembly:

- Set the decade to the X position.
- Grasp the knob firmly with the fingers and pull it straight away from the panel.

CAUTION

To avoid damage to the knob and dial assembly, do not pry the knob loose with a screwdriver or similar flat tool, and do not attempt to twist the knob from the shaft.

c. Release the No. 3-32 set screw in the dial-assembly hub and pull the assembly from the shaft.

● Knob Installation. To install a knob and dial assembly:

- Mount the dial assembly in the correct position on the shaft (see step a under Knob Removal).
- Make certain the dial clears the panel and lock the No. 3-32 set screw.

NOTE

With the dial assembly properly installed, the end of the shaft should not protrude through the dial-assembly hub so that it interferes with proper seating of the knob.

c. Place the knob on the dial-assembly hub and push it in until it snaps into the groove.

Table 3-1

INDUCTANCE PER DECADE - ALL 1491 MODELS (Refer to Figure 3-1)					
	L901	L902	L903	L904	L905
1491-A	940-F 0.01 H steps	940-E 0.001 H steps	940-DD 100 μ H steps	—	—
1491-B	940-H 1 H steps	940-G 0.1 H steps	940-F 0.01 H steps	—	—
1491-C	940-G 0.1 H steps	940-F 0.01 H steps	940-E 0.001 H steps	—	—
1491-D	940-H 1 H steps	940-G 0.1 H steps	940-F 0.01 H steps	940-E 0.001 H steps	—
1491-F	940-G 0.1 H steps	940-F 0.01 H steps	940-E 0.001 H steps	940-DD 100 μ H steps	—
1491-G	940-H 1 H steps	940-G 0.1 H steps	940-F 0.01 H steps	940-E 0.001 H steps	940-DD 100 μ H steps

PARTS LIST

Ref. No.	Description	Part No.
J901	JACK, Binding-post assembly	0938-3000
J902	JACK, Binding-post assembly	0938-3000
J903	JACK, Binding-post assembly	0938-3022
L901*	INDUCTOR ASSEMBLY, 940-DD, 100- μ H steps	0940-3390
thru	INDUCTOR ASSEMBLY, 940-E, 0.001-H steps	0940-3350
L905	INDUCTOR ASSEMBLY, 940-F, 0.01-H steps	0940-3360
	INDUCTOR ASSEMBLY, 940-G, 0.1-H steps	0940-3370
	INDUCTOR ASSEMBLY, 940-H, 1-H steps	0940-3380

Mechanical Replacement Parts

DIAL, Marked 0 to X	5120-2122
KNOB, Bar	5500-5420
WIRE LINK, Connector, ground strap	5080-4800
FOOT	5260-2060
SCREWS, Cabinet, No. 10-32, 3/8	7098-0200
O-RING, Cabinet assembly, 5/32	5855-0156

*Direct replacement units for 1491; refer to 940 specifications for individual units complete with dials and knobs. Refer to Table 3-1 for list of 940 inductors used with specific 1491 models.

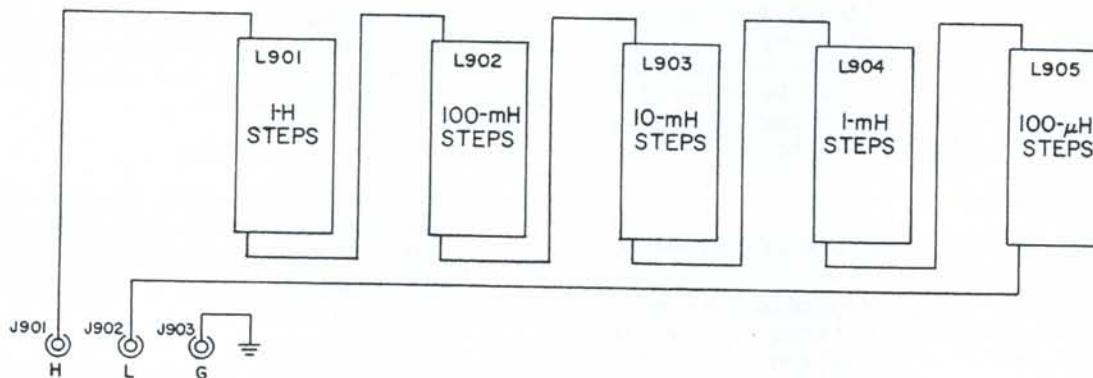

1491-2X

Figure 3-1. Wiring diagram for 1491-G Decade Inductor. Wiring for all other 1491 models is the same, except for the number of decades used.

TYPE 940 DECADE-INDUCTOR UNIT

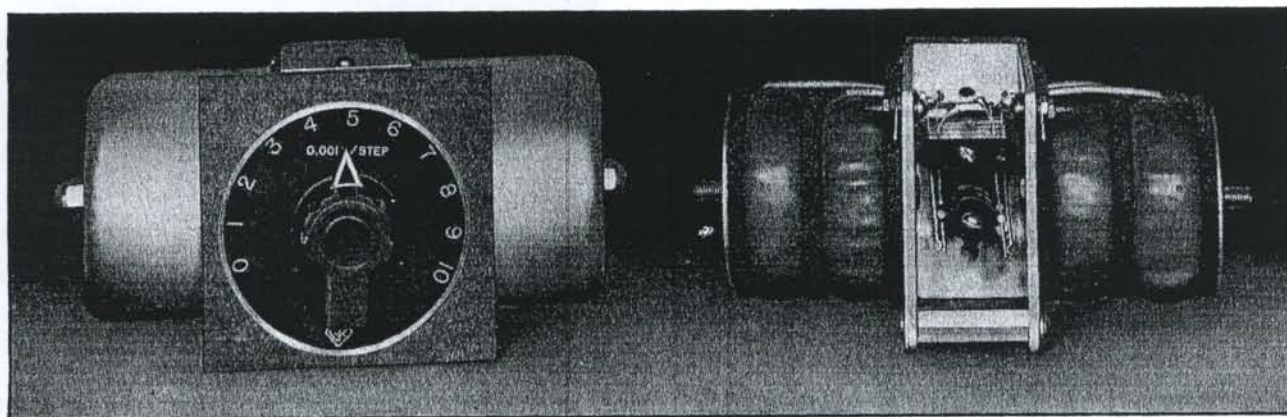

USES: The TYPE 940 Decade-Inductor Units are convenient elements for use in wave filters and tuned circuits throughout the audio and low radio-frequency range. As components in oscillators, analyzers, and similar equipment, they are especially useful during the preliminary design period when the ability to vary circuit elements over relatively wide ranges is necessary to determine optimum operating values. As moderately precise standards of inductance they have storage factor Q values which are much larger than can be obtained with air-cored coils.

DESCRIPTION: Each unit is an assembly of four toroids wound on molybdenum-permalloy dust cores. All four coils (relative values 1, 2, 2, 5) are connected in series, and the switch, a modified TYPE 920, short-circuits

combinations of the coils to give the eleven successive values from 0 to 10. The switch blades are phosphor bronze with silver overlay to decrease both contact and volume resistance.

FEATURES: ▶ High values of storage factor Q are obtained in all models, with maximum values over 200.

▶ Toroidal construction practically eliminates any external magnetic field, and makes it possible to stack the coils closely without trouble from mutual inductances. The toroids are nearly astatic to external magnetic fields.

▶ Electrostatic shielding and mechanical protection are furnished by the aluminum frame and covers.

▶ Moisture is kept from the windings by wax impregnation.

SPECIFICATIONS

Accuracy: Each unit is adjusted so that its inductance at zero frequency and initial permeability will be the nominal value within the accuracy tolerance given in the following table:

Inductance per step	1 mh	10 mh	100 mh	1 h
Accuracy	±2%	±1%	±0.5%	±0.25%

Frequency Characteristics: The equivalent inductance of these units in terms of the nominal inductance L is given by the following equation:

$$L(\text{equivalent}) = \frac{L}{1 - \omega^2 C_0 L}$$

Typical values for the distributed capacitance C_0 of the TYPE 940-A Decade-Inductor Unit are as follows:

Step	1	2	3	4	5	6	7	8	9	10
C_0 (μmf); Chassis tied to Low Terminal	90	60	50	50	50	45	40	37	35	35
C_0 (μmf); Chassis Floating	45	45	35	35	50	40	35	32	30	25

For the TYPES 940-B, -C, and -D the above values should be multiplied by the factors 1.1, 1.25, and 1.5 respectively.

Current Characteristics and Maximum Current Ratings: The core permeability and the inductance value of each toroid are raised 0.1% by the application

of 1.20 ampere turns. The corresponding r-m-s current values I_1 for each of the toroids are listed below, together with the r-m-s current values I_2 corresponding to a safe heat dissipation of two watts per toroid.

Inductor	Toroid	I_1 (ma) for 0.1% increase	I_2 (amp)
940-A	1 mh	15.1	7.2
940-A	2 mh	10.7	5.2
940-A	5 mh	6.8	3.0
940-B	10 mh	4.8	2.3
940-B	20 mh	3.4	1.7
940-B	50 mh	2.1	1.0
940-C	100 mh	1.51	0.72
940-C	200 mh	1.07	0.52
940-C	500 mh	0.68	0.30
940-D	1 h	0.48	0.23
940-D	2 h	0.34	0.17
940-D	5 h	0.21	0.10

Currents of about $6 I_1$ will produce 0.5% increase in inductance; $25 I_1$ gives 1% increase; about $45 I_1$ gives a maximum increase of 2%, while still larger currents

produce a drop in inductance, the error being zero at about 100 I₁. The I₂ values may reduce L to about 70% of its initial value.

Dissipation Factor: The accompanying plot shows the variation of the dissipation factor $D = 1/Q$ with frequency for the full value of each inductor (see page 43). It will be seen that maximum storage factor Q values between 200 and 330 are obtained at frequencies between 2 and 5 kc.

Temperature Coefficient: The temperature coefficient of inductance is about +50 parts per million per degree Centigrade.

Maximum Voltage: The maximum r-m-s voltage for which the units are insulated is 500 volts. The switch will break the circuit at 500 volts if turned rapidly to the new setting, but voltages above 150 may cause destructive arcing if the switch is set between detent positions.

Terminals: Soldering lugs are provided.

Mounting: Each decade is complete with dial plate, knob, and mounting screws.

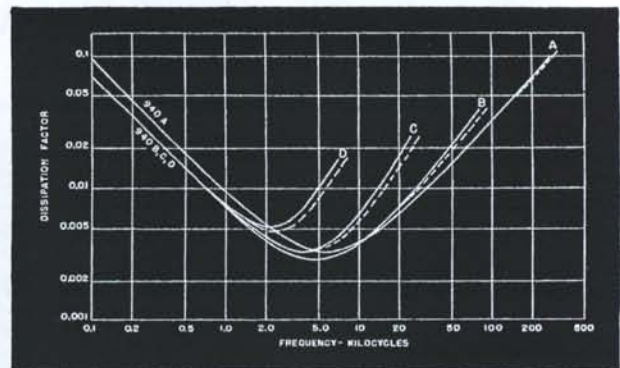

Variation of dissipation factor for the full value of each inductor. Dashed curves correspond to use with chassis floating.

Dimensions: (Width) 7 1/4 x (height) 3 1/2 x (depth behind panel) 3 1/4 inches, over-all.

Net Weight: 3 1/2 pounds.

Type	Inductance	Code Word	Price
940-A	0.01 h in 0.001 h steps	INDUCTOANT	Price on Request
940-B	0.1 h in 0.01 h steps	INDUCTOBOY	
940-C	1 h in 0.1 h steps	INDUCTOCAT	
940-D	10 h in 1 h steps	INDUCTODOG	

TYPE 1490 DECADE INDUCTOR

USES: Where an adjustable inductance covering a very wide range is required these boxes will be extremely useful.

DESCRIPTION: The TYPE 1490 Decade Inductor is an assembly of three or four TYPE 940 Decade-Inductor Units in a single metal cabinet. The units have no electrical connection to the panel but a separate ground terminal is provided which may be connected to the "low" terminal of the smallest unit.

SPECIFICATIONS

Frequency Characteristics: In determining the correction factor $\omega^2 C_0 L$ use the C_0 value corresponding to the largest decade unit actually in circuit. For each larger decade unit not in circuit add 100 $\mu\mu\text{f}$ if the inductor is grounded to the panel or add 20 $\mu\mu\text{f}$ if the inductor is not grounded to the panel.

Terminals: Jack-top binding posts.

Mounting: The decades are mounted on an aluminum panel in a metal cabinet.

Dimensions: 1490-A 12 3/4 x 7 3/4 x 5 1/2 inches over-all height. 1490-B 16 1/2 x 7 3/4 x 5 1/2 inches over-all height.

Net Weight: TYPE 1490-A, 15 pounds; TYPE 1490-B, 19 pounds.

Other specifications are identical with those for the TYPE 940-Decade-Inductor Units.



Type	Inductance
1490-A	1 h, total, in steps of 0.001 h
1490-B	10 h, total, in steps of 0.001 h

SCHEMATIC DIAGRAM FOR 940 DECADE INDUCTOR

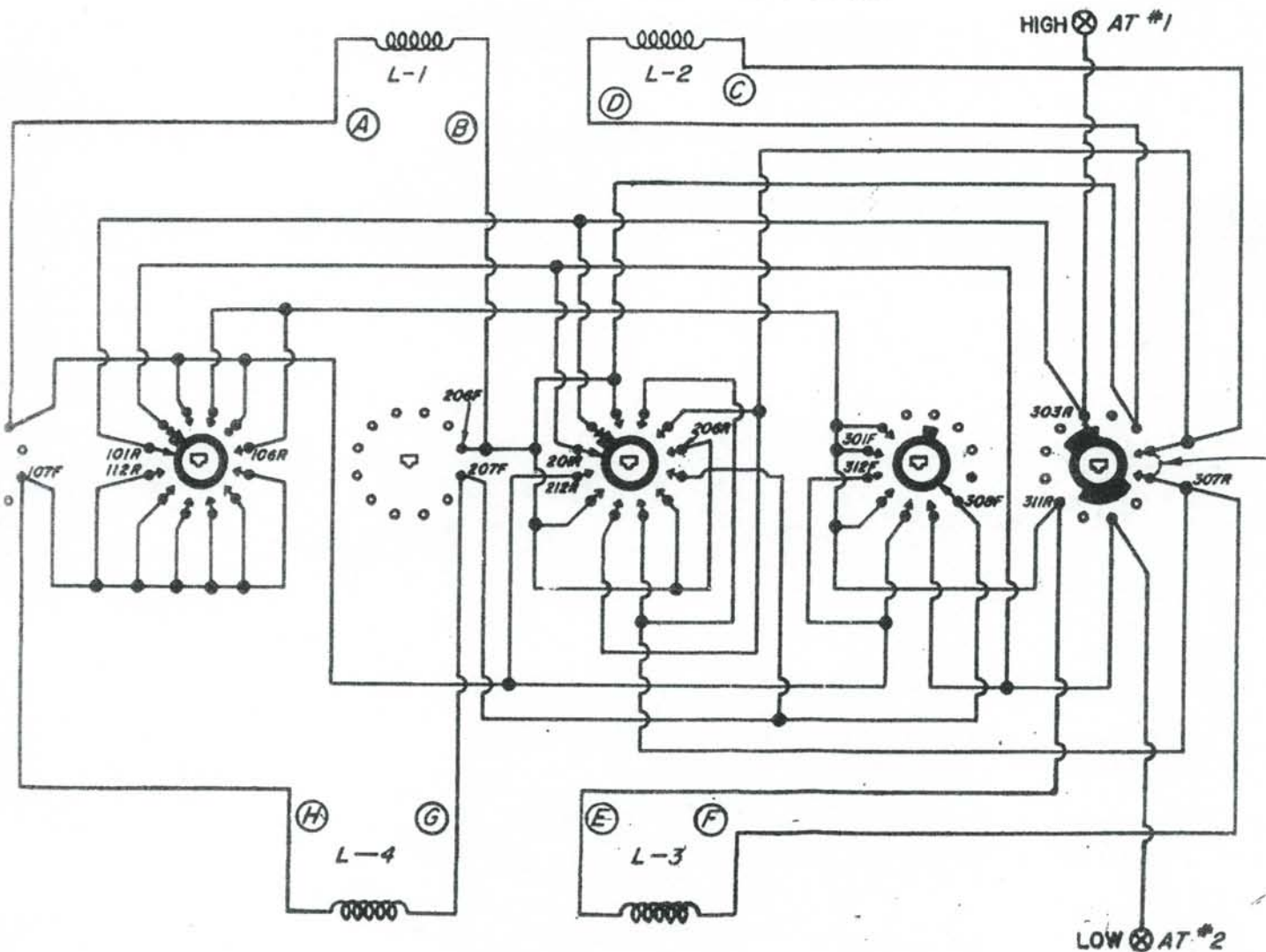

- FOR 940-330 (940-E) 940-334 (940-BD) ONLY
CONNECT S-1, 306R TO S-1, 307R

TYPE	ASM. NO.	L-1		L-2		L-3		L-4		S-1
		VALUE	PART NO.	VALUE	PART NO.	VALUE	PART NO.	VALUE	PART NO.	
940-E	940-330	1mh	940-301	2mh	940-302	2mh	940-302	5mh	940-303	SWEN-165
940-F	940-331	10mh	940-304	20mh	940-305	20mh	940-305	50mh	940-306	SWEN-165
940-G	940-332	100mh	940-307	200mh	940-308	200mh	940-308	500mh	940-309	SWEN-165
940-H	940-333	1h	940-310	2h	940-311	2h	940-311	5h	940-312	SWEN-165
940-BD	940-334	100µh	940-351	200µh	940-352	200µh	940-352	500µh	940-353	SWEN-165

SWITCHING SCHEDULE

SWITCH POSITION	INDUCTORS IN CIRCUIT			
	L-1	L-2	L-3	L-4
+0				
1	X			
2			X	
3	X	X		
4		X	X	
5				X
6	X			X
7			X	X
8	X	X	X	X
9		X	X	X
10	X	X	X	X

* Extreme CCM as shown

940 DECADE INDICATOR

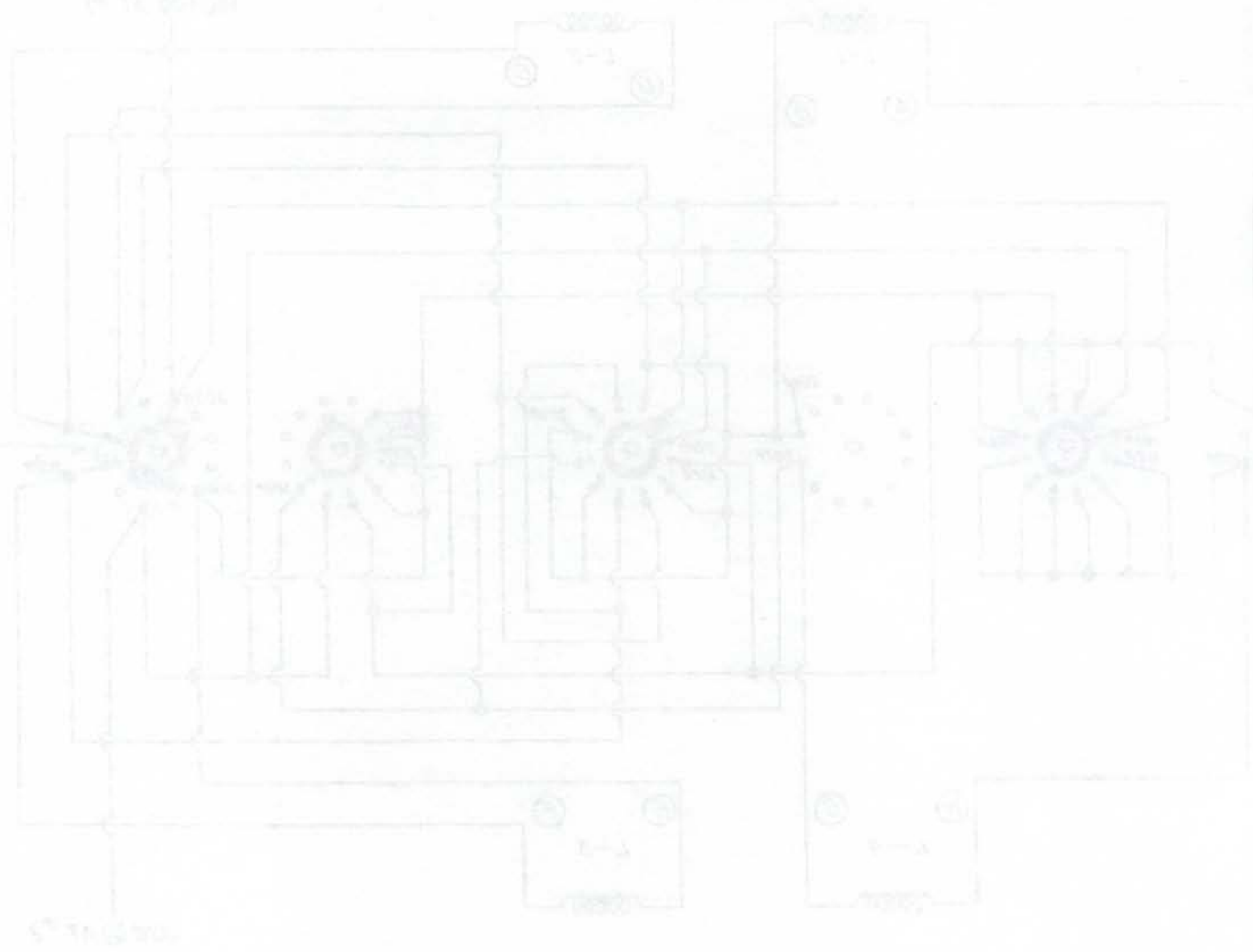

THE IET LABORATORIES, INC. • 534 MAIN STREET • WESTBURY, NY 11590 • TEL: (516) 334-5959 • (800) 899-8438 • FAX: (516) 334-5988 • WWW.IETLABS.COM

TABLE 1: Pin Connections

Pin	Function
1	100K
2	100K
3	100K
4	100K
5	100K
6	100K
7	100K
8	100K
9	100K
10	100K

TABLE 2: Decade Counter Connections

IC	Pin 1	Pin 2	Pin 3	Pin 4	Pin 5	Pin 6	Pin 7	Pin 8	Pin 9	Pin 10
IC1	100K	100K	100K	100K	100K	100K	100K	100K	100K	100K
IC2	100K	100K	100K	100K	100K	100K	100K	100K	100K	100K
IC3	100K	100K	100K	100K	100K	100K	100K	100K	100K	100K
IC4	100K	100K	100K	100K	100K	100K	100K	100K	100K	100K



IET LABS, INC.

Standards • Decades • Strobes • Sound Level Meters • Bridges

Formerly manufactured by

GenRad

534 Main Street, Westbury, NY 11590

TEL: (516) 334-5959 • (800) 899-8438 • FAX: (516) 334-5988

www.ietlabs.com